



# SYNERGY

INNOVATIVE DIVING EQUIPMENT TRADING LLC

INSPIRING • ENGINEERING • INNOVATION



ISO 45001:2018 OHSMS



AN ISO 14001:2015 EMS CERTIFIED COMPANY



## SYNERGY HYPERBARIC CARBON DIOXIDE CLEARFLOW SCRUBBER SY-SBHS-241



SYNERGY INNOVATIVE DIVING EQUIPMENT TRADING LLC

AIR

## SYNERGY HYPERBARIC CARBON DIOXIDE CLEARFLOW SCRUBBER SY-SBHS-241



SR	DESCRIPTION
1	Powder coated stainless steel enclosure
2	Rugged powder coated stainless steel mounting bracket
3	Power requirement 1.5 amps 12v-24v ac
4	Papst motor 12v to 24v ac (designed to work in high levels of oxygen without electrical sparks)
5	Constant circulation of Air= Co2, water vapor & odor absorption
6	Co2 Absorbent - SOFNOLIME 7.5 lbs
7	Gas flows @ 1 atmosphere - 0.85 m3/min
8	Effective for 30 mans approx per refill of co2 absorbent
9	Weight including mounting bracket 13.5 kgs

Sr.	Part Number	Description
1	SY-RMG-3-MP	Marsh Marine, 3 pin , Male, 18"
2	SY-RMG-3-FS	Marsh Marine, 3 pin, Female, 18"



## SYNERGY HYPERBARIC CARBON DIOXIDE CLEARFLOW SCRUBBER SY-SBHS-241

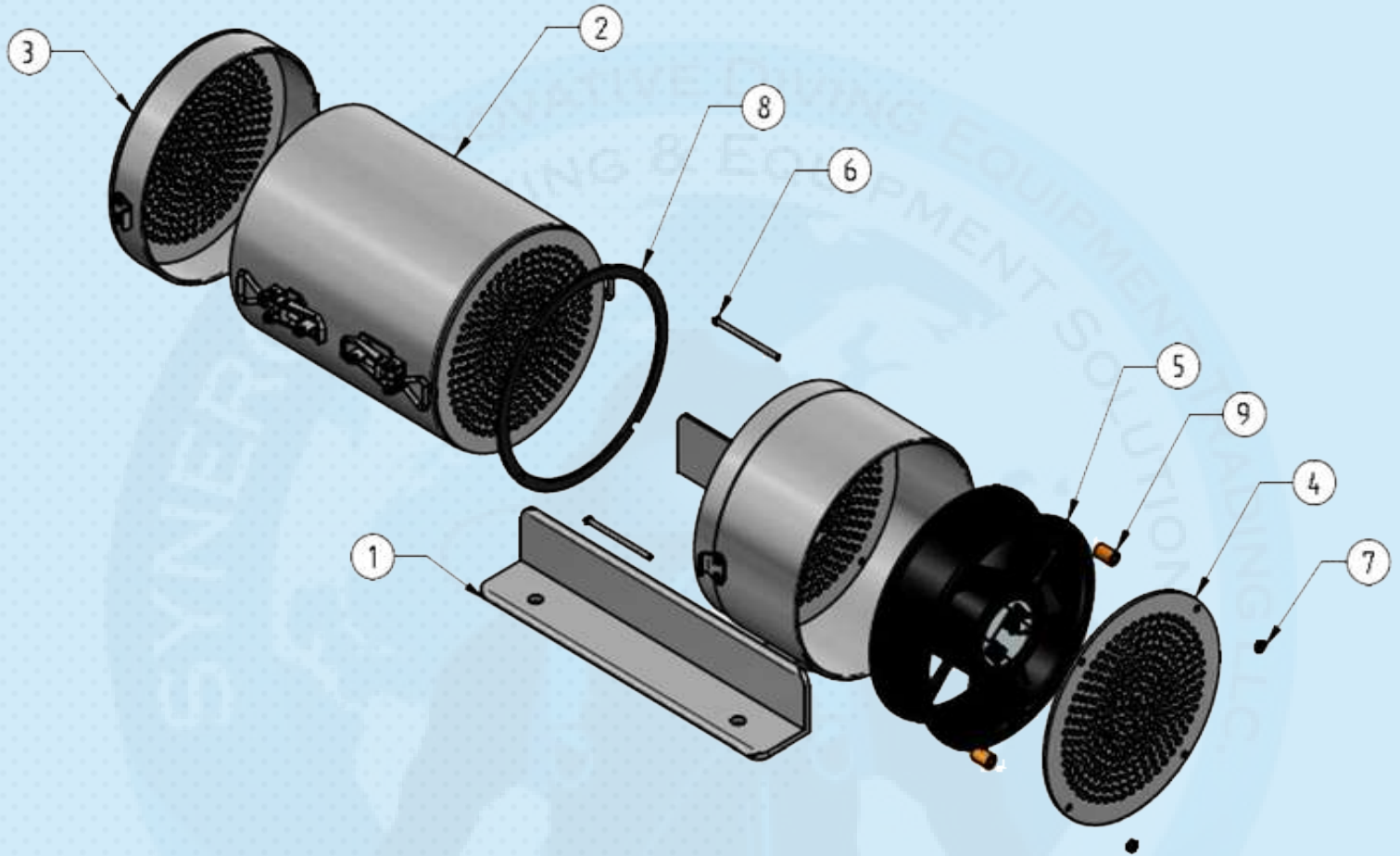

SR	Part Number	Description	Qty
1	SY-SB-S012-1	Base body weldment	1
2	SY-SB-S012-2	Middle body_weldment	1
3	SY-SB-S012-3	Top cover body_weldment	1
4	SY-SB-S012-4	Closing plate -1 for base body	1
5	SY-SB-S012-5	Fan-6224n-ebmpapst	1
6	SY-STD	Screw_m4	2
7	SY-STD	Nut_m4	2
8	SY-SB-S012-6	Gasket	1
9	SY-SB-S012-7	Spacer	2

### ORDERING INFORMATION

SR	Part Number	Part Number
1	SY-SBHS-241	HYPERBARIC CO2 SCRUBBER, 12V AC

## SYNERGY INFRASTRUCTURE





# SYNERGY

INNOVATIVE DIVING EQUIPMENT TRADING LLC

INSPIRING • ENGINEERING • INNOVATION









UAE • UK





## SYNERGY HYPERBARIC CARBON DIOXIDE CLEARFLOW SCRUBBER SY-SBHS-241

### Contact us

 P.O. Box – 237849, Warehouse No 8,  
Al Maidoor Warehouse, Al Qusais,  
Industrial Area - Dubai - UAE

-  Tel : 009714 2580533 
-  Fax : 009714 2580534 
-  UAE : 00971505648178 
-  UK : 00447951966260 

-  Website : [www.synergiequipment.com](http://www.synergiequipment.com)
-  Email : [ram@synergiequipment.com](mailto:ram@synergiequipment.com)
-  For Sale : [info@synergiequipment.com](mailto:info@synergiequipment.com)

